

Kos.

V.i.P. by Wiemann



Independent / incl. HDI

RETAIL PRICE LIST

valid

01.03.2023-31.08.2023



Emission Tested
Tested for Harmful
Substances
Regular Product
Surveillance

www.tuv.com
ID 1111263053



Carcase and front colours

Please specify the exact colour combination of front and carcase colour for each order!

Designs:

Carcase

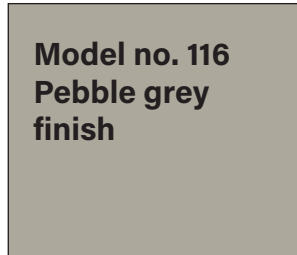
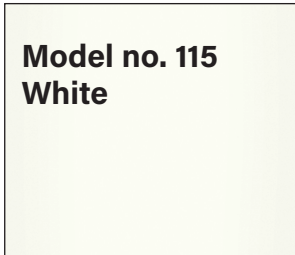

Glass fronts



Mirror

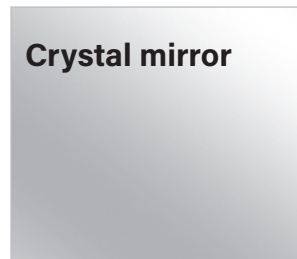

Interior colour

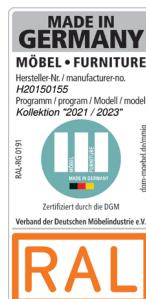

Kos.

V.i.P. by Wiemann



Independent / incl. HDI

RETAIL PRICE LIST

valid

01.03.2023-31.08.2023



Emission Tested
Tested for Harmful
Substances
Regular Product
Surveillance

www.tuv.com
ID 1111263053



Kos.**V.i.P.**
by Wiemann**Carcase width****Sliding door wardrobes**

Width	Side	Plinth	Side	Plinth	Side	Plinth	Side	Plinth	Side			Width effective
200	1,5	96,4	1,5	96,4	1,5							197,3 cm
250	1,5	80,1	1,5	80,1	1,5	80,1	1,5					246,3 cm
280	1,5	96,4	1,5	80,1	1,5	96,4	1,5					278,9 cm
300	1,5	96,4	1,5	96,4	1,5	96,4	1,5					295,2 cm
330	1,5	80,1	1,5	80,1	1,5	80,1	1,5	80,1	1,5			327,9 cm
400	1,5	96,4	1,5	96,4	1,5	96,4	1,5	96,4	1,5			393,1 cm

Important instructions

We reserve the right to color and model deviations or the correction of erroneous information. All measures are approximate cm.

Kos.

Independent / incl. HDI

RETAIL PRICE LIST



valid

01.03.2023-31.08.2023

V.i.P.
by Wiemann

Sliding door wardrobes
Handles in carcass colour

Interior:
2 adjustable shelves, 1 clothes rail

Description	Dimensions cm		Height 217 cm		Height 236 cm	
	W	D	Art. no.	GBP	Art. no.	GBP
Front in glass white						
	2 doors	200	67	528	2143,-	534 2263,-
	3 doors	250	67	529	2290,-	535 2410,-
	3 doors	280	67	530	2490,-	536 2610,-
	3 doors	300	67	531	2520,-	537 2640,-
	- with synchronous opening					
	4 doors	330	67	532	3240,-	538 3363,-
	4 doors	400	67	533	3498,-	539 3663,-

Plinth partition

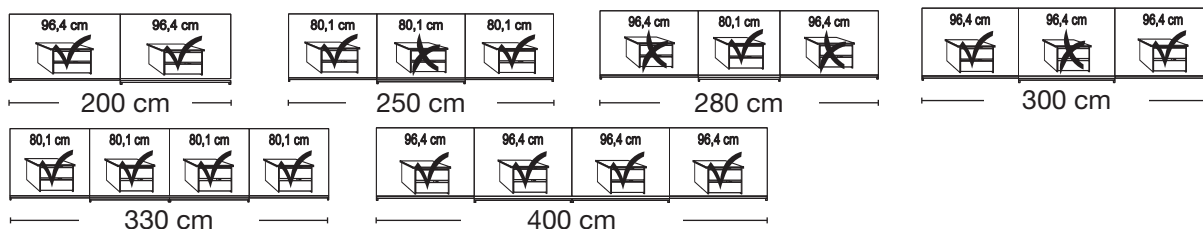

Sliding door wardrobes

Handles in carcass colour

Interior:

2 adjustable shelves, 1 clothes rail

Description	Dimensions cm		Height 217 cm		Height 236 cm	
	W	D	Art. no.	GBP	Art. no.	GBP
Glass doors in white and crystal mirrored doors						
	2 doors 1 mirrored door left	200	67	540	2143,-	553 2263,-
	2 doors 1 mirrored door right	200	67	541	2143,-	554 2263,-
	2 doors 2 mirrored doors	200	67	542	2143,-	555 2263,-
	3 doors 1 centre mirrored door	250	67	543	2290,-	556 2410,-
	3 doors 3 mirrored doors	250	67	544	2290,-	557 2410,-
	3 doors 1 centre mirrored door	280	67	545	2490,-	558 2610,-
	3 doors 3 mirrored doors	280	67	546	2490,-	559 2610,-
	3 doors 1 centre mirrored door	300	67	547	2520,-	560 2640,-
	3 doors 3 mirrored doors	300	67	548	2520,-	561 2640,-
- with synchronous opening						
	4 doors 2 centre mirrored doors	330	67	549	3240,-	562 3363,-
	4 doors 4 mirrored doors	330	67	550	3240,-	563 3363,-
	4 doors 2 centre mirrored doors	400	67	551	3498,-	564 3663,-
	4 doors 4 mirrored doors	400	67	552	3498,-	565 3663,-

Plinth partition

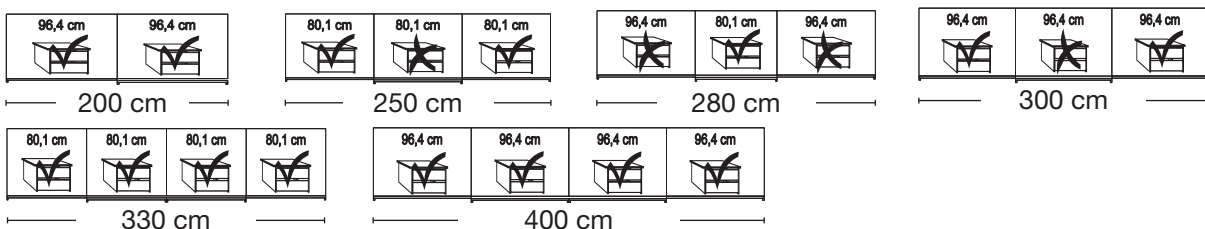

Kos.

Independent / incl. HDI

RETAIL PRICE LIST

valid



01.03.2023-31.08.2023

V.i.P.
by Wiemann

Sliding door wardrobes
Handles in carcase colour

Interior:

2 adjustable shelves, 1 clothes rail

Description	Dimensions cm		Height 217 cm		Height 236 cm	
	W	D	Art. no.	GBP	Art. no.	GBP
Front in glass pebble grey						
	2 doors	200	67	566	2143,-	572 2263,-
	3 doors	250	67	567	2290,-	573 2410,-
	3 doors	280	67	568	2490,-	574 2610,-
	3 doors	300	67	569	2520,-	575 2640,-
	- with synchronous opening					
	4 doors	330	67	570	3240,-	576 3363,-
	4 doors	400	67	571	3498,-	577 3663,-

Plinth partition

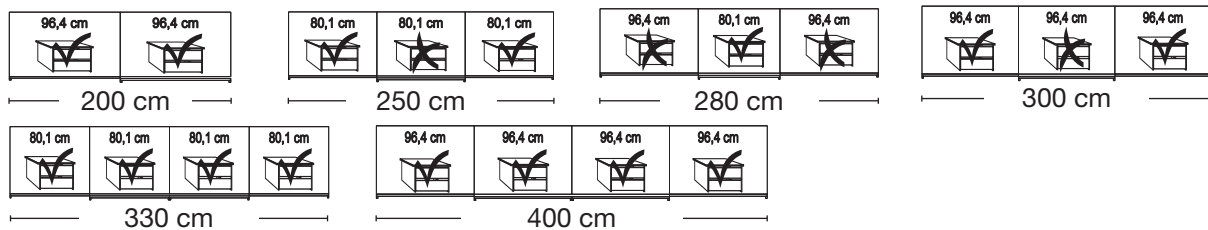

Kos.

Independent / incl. HDI

RETAIL PRICE LIST





valid

01.03.2023-31.08.2023

V.i.P.
by Wiemann

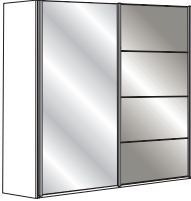
Sliding door wardrobes
Handles in carcase colour

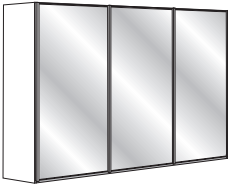



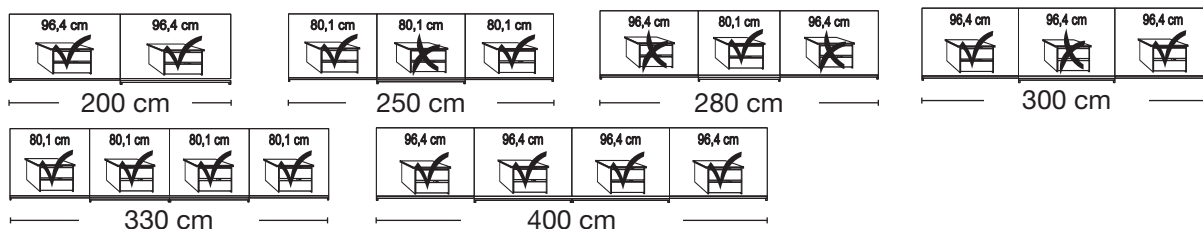

Interior:
2 adjustable shelves, 1 clothes rail

Description	Dimensions cm		Height 217 cm		Height 236 cm	
	W	D	Art. no.	GBP	Art. no.	GBP
Glass doors in pebble grey and crystal mirrored doors						
	2 doors 1 mirrored door left	200	67	578	2143,-	591 2263,-
	2 doors 1 mirrored door right	200	67	579	2143,-	592 2263,-
	2 doors 2 mirrored doors	200	67	580	2143,-	593 2263,-
	3 doors 1 centre mirrored door	250	67	581	2290,-	594 2410,-
	3 doors 3 mirrored doors	250	67	582	2290,-	595 2410,-
	3 doors 1 centre mirrored door	280	67	583	2490,-	596 2610,-
	3 doors 3 mirrored doors	280	67	584	2490,-	597 2610,-
	3 doors 1 centre mirrored door	300	67	585	2520,-	598 2640,-
	3 doors 3 mirrored doors	300	67	586	2520,-	599 2640,-
- with synchronous opening						
	4 doors 2 centre mirrored doors	330	67	587	3240,-	600 3363,-
	4 doors 4 mirrored doors	330	67	588	3240,-	601 3363,-
	4 doors 2 centre mirrored doors	400	67	589	3498,-	602 3663,-
	4 doors 4 mirrored doors	400	67	590	3498,-	603 3663,-

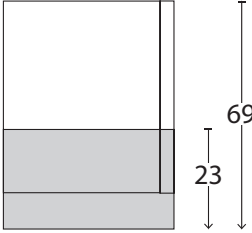

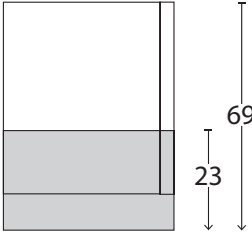
Plinth partition

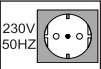

Cornices for sliding-door wardrobes
with or without lights

Description	Dimensions cm			Art. no.	GBP
	W	H	D		
 <p>Cornice, without lights</p> <p>- for width 200 cm - for width 250 cm - for width 280 cm - for width 300 cm - for width 330 cm - for width 400 cm</p> <p>Top view wardrobe incl. cornice</p>  <p>Dimensions cm</p>	200	5	23	677	123,-
	250	5	23	678	125,-
	280	5	23	679	128,-
	300	5	23	680	128,-
	330	5	23	681	218,-
	400	5	23	682	220,-
 <p>Cornice, with lights</p> <p>4 lights - for width 200 cm 6 lights - for width 250 cm 6 lights - for width 280 cm 6 lights - for width 300 cm 8 lights - for width 330 cm 8 lights - for width 400 cm</p> <p>Top view wardrobe incl. cornice</p>  <p>Dimensions cm</p> <p>This product contains light devices of energy efficiency class F</p>   	200	5	23	683	455,-
	250	5	23	684	463,-
	280	5	23	685	465,-
	300	5	23	686	555,-
	330	5	23	687	698,-
	400	5	23	688	703,-

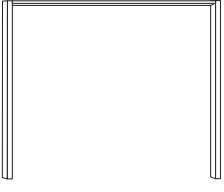
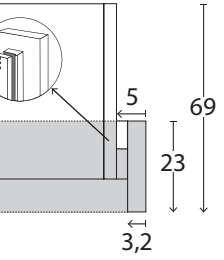
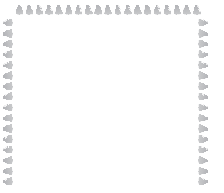
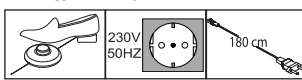

Passe-partout frames for sliding door wardrobes with or without lights

Description	Dimensions		Height 221 cm		Height 240 cm	
	W	D	Art. no.	GBP	Art. no.	GBP
 <p>Passe-partout frame, Width per side profile: 3.2 cm without lights</p> <ul style="list-style-type: none"> - for width 200 cm - for width 250 cm - for width 280 cm - for width 300 cm - for width 330 cm - for width 400 cm <p>Top view wardrobe incl. PPT-Frame</p>  <p>Dimensions cm</p>	210	23	701	300,-	710	335,-
	260	23	703	308,-	712	350,-
	290	23	704	313,-	713	355,-
	310	23	705	315,-	714	363,-
	340	23	707	435,-	716	468,-
	410	23	708	443,-	717	485,-
	<hr/>					
 <p>Surcharge for circumferential LED illumination (optional):</p> <ul style="list-style-type: none"> - for width 200 cm - for width 250 cm - for width 280 cm - for width 300 cm - for width 330 cm - for width 400 cm <p>This product contains light devices of energy efficiency class F</p> 	210	23	738	663,-	747	683,-
	260	23	740	665,-	749	685,-
	290	23	741	673,-	750	688,-
	310	23	742	683,-	751	698,-
	340	23	744	695,-	753	713,-
	410	23	745	718,-	754	738,-
	<p> Can not get assembled retrospectively!</p>					

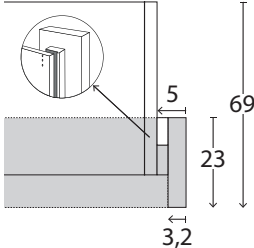
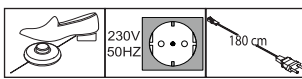



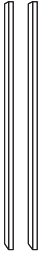
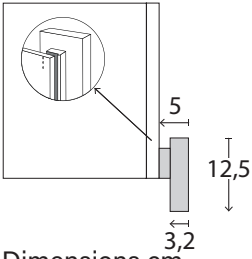

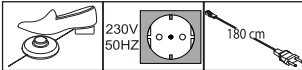
Passe-partout frames for sliding door wardrobes with lights

Description	Dimensions		Height 221 cm		Height 240 cm	
	W	D	Art. no.	GBP	Art. no.	GBP
 <p>Passe-partout frame, Width per side profile: 3.2 cm with lights</p> <p>4 lights - for width 200 cm 6 lights - for width 250 cm 6 lights - for width 280 cm 6 lights - for width 300 cm 8 lights - for width 330 cm 8 lights - for width 400 cm</p>	210	23	719	593,-	728	633,-
	260	23	721	600,-	730	640,-
	290	23	722	683,-	731	718,-
	310	23	723	713,-	732	748,-
	340	23	725	943,-	734	978,-
	410	23	726	950,-	736	988,-
<p>Top view wardrobe incl. PPT-Frame</p>  <p>Dimensions cm</p>						
<p>This product contains light devices of energy efficiency class F</p> 						

**Additional elements
for sliding door wardrobes**

Description	Dimensions cm		Height 217 cm		Height 236 cm	
	W	D	Art. no.	GBP	Art. no.	GBP
 <p>Side profiles in carcase colour, pair</p> <p>Top view wardrobe incl. side profiles</p>  <p>Dimensions cm</p>	5	12,5	098	150,-	099	158,-
 <p>Lights for side profiles</p> <p> Can not get assembled retrospectively! Useabl for side profiles and PPT-Frame wit- hout circumferential lights!</p> <p>This product contains light devices of energy efficiency class F</p> 	1,5	1	100	578,-	101	658,-

Unit accessories

Description	Dimensions cm			Art. no.	GBP
	W	H	D		
 <p>Bumper</p> <p>- for 2-doors wardrobes 1 item</p> <p> Optimal functioning only in combination with self-closing mechanism for outer doors</p> <p>- for 3-4 door wardrobes 2 items</p> <p> Best performance in conjunction with soft closing mechanism!</p>	28	4	2	369	63,-
 <p>Soft-closing mechanism for middle doors</p> <p>*</p> <p>- for 3-door units piece</p> <p>- for 4-door units piece</p> <p> * Please pay attention to clearance between wardrobe and ceiling! To be fitted from top of the wardrobe!</p>	24	2	11	363	115,-
 <p>2-piece set self-closing mechanism with buffering for outer doors, Set for 2-,3- and 4-doors</p> <p>pair</p>	24	2	11	365	150,-









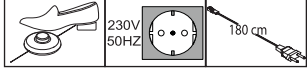

Kos.

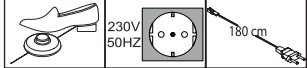
Independent / incl. HDI

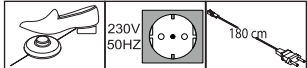
RETAIL PRICE LIST

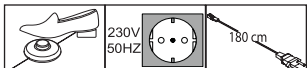
valid

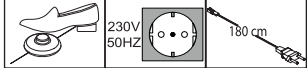
01.03.2023-31.08.2023**V.i.P.**
by Wiemann**Unit accessories**

Description	Dimensions cm			Art. no.	GBP	
	W	H	D			
 <p>LED Clip-On-Lights, silver</p> <p>This product contains light devices of energy efficiency class E</p> 	1 item	60	1,5	4,5	980	168,-
	2 items	60	1,5	4,5	981	243,-
	3 items	60	1,5	4,5	982	315,-
	 Only in conjunction with PPT-Frame and cornice!					
 <p>LED line light, silver</p> <p>This product contains light devices of energy efficiency class E</p> 	1 item	60	6	19	983	168,-
	2 items	60	6	19	984	243,-
	3 items	60	6	19	985	315,-
	 Only in conjunction with PPT-Frame and cornice!					
 <p>LED Clip-On-Lights, black</p> <p>This product contains light devices of energy efficiency class E</p> 	1 item	60	1,5	4,5	880	168,-
	2 items	60	1,5	4,5	881	243,-
	3 items	60	1,5	4,5	882	315,-
	 Only in conjunction with PPT-Frame and cornice!					
 <p>LED line light, black</p> <p>This product contains light devices of energy efficiency class E</p> 	1 item	60	6	19	883	168,-
	2 items	60	6	19	884	243,-
	3 items	60	6	19	885	315,-
	 Only in conjunction with PPT-Frame and cornice!					
 <p>LED top light, chrome</p> <p>This product contains light devices of energy efficiency class F</p> 	1 item	5,5	3	22,5	970	200,-
	2 items	5,5	3	22,5	971	283,-
	3 items	5,5	3	22,5	972	363,-
	 Only in conjunction with PPT-Frame and cornice!					

Kos.

Independent / incl. HDI

RETAIL PRICE LIST

valid

01.03.2023-31.08.2023**V.i.P.**
by Wiemann**Unit accessories****Interior finish: silver grey striped**

When ordering more than one accessory item for a compartment, please make sure that all accessories do not interfere with each other's function.

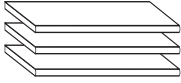
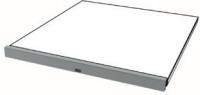
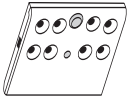
Description	Dimensions cm			Art. no.	GBP	
	W	H	D			
 <p>1 shelf</p> <p>- for compartment width 80.1 cm 1 item - for compartment width 96.4 cm 1 item</p>	80,1	2,2	51,5	032	75,-	
	96,4	2,2	51,5	030	80,-	
 <p>3 shelves</p> <p>- for compartment width 80.1 cm 3 items - for compartment width 96.4 cm 3 items</p>	80,1	2,2	51,5	033	138,-	
	96,4	2,2	51,5	031	145,-	
 <p>This product contains a light device of energy efficiency class F</p> <p>LED Light screen for shelves</p> <p>- for compartment width 80.1 cm piece - for compartment width 96.4 cm piece</p> <p>- for compartment width 80.1 cm 2 items - for compartment width 96.4 cm 2 items</p> <p>- for compartment width 80.1 cm 3 items - for compartment width 96.4 cm 3 items</p>	80,1	3	1	016	190,-	
	96,4	3	1	011	195,-	
	80,1	3	1	017	323,-	
	96,4	3	1	013	330,-	
	80,1	3	1	018	440,-	
	96,4	3	1	015	468,-	
 <p>LED Wardrobe interior lights with motion detector, incl. rechargeable battery via USB</p> <p>1 item 2 items 3 items 4 items</p>	10	2	10	006	105,-	
	10	2	10	007	178,-	
	10	2	10	008	258,-	
	10	2	10	009	330,-	

Kos.



Independent / incl. HDI

RETAIL PRICE LIST

valid

01.03.2023-31.08.2023**V.i.P.**
by Wiemann**Unit accessories****Interior finish: silver grey striped**

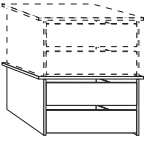
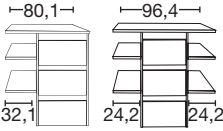
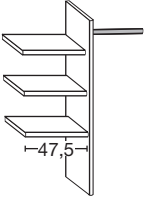
When ordering more than one accessory item for a compartment, please make sure that all accessories do not interfere with each other's function.

	Description	Dimensions cm			Art. no.	GBP
		W	H	D		
	Drawer insert with 2 drawers and glass front - for compartment width 80.1 cm - for compartment width 96.4 cm	80,1 96,4	41 41	52 52	069 070	463,- 478,-
	Drawer insert with 2 drawers and wooden front, stackable and height adjustable - for compartment width 80.1 cm - for compartment width 96.4 cm	80,1 96,4	41 41	44 44	072 073	468,- 478,-
	Drawer insert with 3 drawers and wooden front - for compartment width 80.1 cm - for compartment width 96.4 cm	80,1 96,4	89 89	51,5 51,5	024 064	613,- 628,-
	Laundry shelf insert, consisting of: 3 adjustable shelves, 1 hanging rail, 1 mid panel - for compartment width 80.1 cm - for compartment width 96.4 cm	80,1 96,4	137 137	51,5 51,5	026 066	245,- 250,-
	For use on both sides (left or right)! Only to be placed on base plinth!					

Kos.

Independent / incl. HDI

RETAIL PRICE LIST

valid

01.03.2023-31.08.2023**V.i.P.**
by Wiemann**Unit accessories**

When ordering more than one accessory item for a compartment, please make sure that all accessories do not interfere with each other's function.

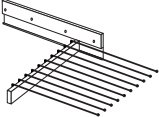
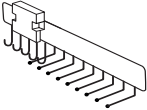
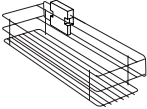
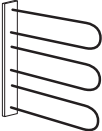
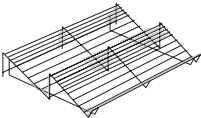
Description	Dimensions cm			Art. no.	GBP
	W	H	D		
 <p>Trousler holder</p>	45	10	50	056	270,-
 <p>Tie and belt pull-out</p>	7	19	45	059	123,-
 <p>Utensil pull-out</p>	16	9	45	076	138,-
 <p>Tie and belt rack</p>	30	27	9	042	60,-
 <p>Shoe rack for unit compartment W 96.4 cm</p>	96	15	50	094	113,-

Kos.



Independent / incl. HDI

RETAIL PRICE LIST

valid

01.03.2023-31.08.2023**V.i.P.**
by Wiemann**Unit accessories****Interior finish: silver grey striped**

When ordering more than one accessory item for a compartment, please make sure that all accessories do not interfere with each other's function.

Description	Dimensions cm			Art. no.	GBP
	W	H	D		
 <p>Clothes lift for compartment width 72.3 - 96.4 cm</p>	100	85	14	081	200,-
 <p>Fold-out interior mirror</p> <p> Not for use in conjunction with LED light screens!</p>	36	173	2	080	250,-

Kos.

Independent / incl. HDI

RETAIL PRICE LIST

valid

01.03.2023-31.08.2023

V.i.P.
by Wiemann**Futon beds**

Footboard height: 48 cm

4-position height adjustment

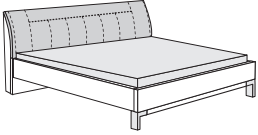
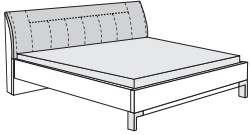
Description	Bed surface in cm	Surface in cm	Art. no.	GBP
 <p>Headboard cushion in faux leather white, Angled feet in silver</p> <p>Headboard height: 97 cm Footboard height: 48 cm Height to bed side top edge: 48 cm</p>	140 x 190	149 x 208	472	1283,-
	150 x 200	169 x 218	205	1283,-
	160 x 200	169 x 218	477	1283,-
	180 x 200	189 x 218	485	1283,-
 <p>Headboard cushion in faux leather pebble grey, Angled feet in silver</p> <p>Headboard height: 97 cm Footboard height: 48 cm Height to bed side top edge: 48 cm</p>	140 x 190	149 x 208	321	1283,-
	150 x 200	169 x 218	206	1283,-
	160 x 200	169 x 218	326	1283,-
	180 x 200	189 x 218	334	1283,-

Kos.

Independent / incl. HDI

RETAIL PRICE LIST





valid

01.03.2023-31.08.2023

V.i.P.
by Wiemann**Additional elements
for beds**

Description	Dimensions cm			Art. no.	GBP
	W	H	D		
 <p>Pair of slatted bases</p> <p>- for bed 140 x 190 cm</p> <p>- for bed 150 x 200 cm</p> <p>- for bed 160 x 200 cm</p> <p>- for bed 180 x 200 cm</p>	140	8	190	106 330	190,-
	150	8	200	106 340	190,-
	160	8	200	106 350	190,-
	180	8	200	106 360	190,-

Bedside cabinets, 3 drawers

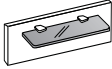
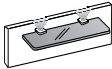
	Description	Dimensions cm			Art. no.	GBP		
		W	H	D				
	Bedside cabinet, 3 drawers							
	- Drawers glass white	piece	40	48	43	267	440,-	
		pair	40	48	43	268	868,-	
	Height 48 cm	piece	60	48	43	269	480,-	
		pair	60	48	43	270	945,-	
	- Drawers glass pebble grey	piece	40	48	43	271	440,-	
		pair	40	48	43	272	868,-	
		piece	60	48	43	273	480,-	
		pair	60	48	43	274	945,-	
	- Drawers glass white	piece	40	64	43	275	458,-	
		pair	40	64	43	276	903,-	
		piece	60	64	43	277	505,-	
		pair	60	64	43	278	993,-	
	Height 64 cm	- Drawers glass pebble grey	piece	40	64	43	279	458,-
			pair	40	64	43	280	903,-
		piece	60	64	43	281	505,-	
		pair	60	64	43	282	993,-	
	Beside cabinet panel, with smoked glass shelf	piece	40	20	12	300	125,-	
		pair	40	20	12	301	200,-	
		piece	60	20	12	302	125,-	
		pair	60	20	12	303	200,-	
	Bedside cabinet panel with smoked glass shelf and LED-lights	piece	40	20	12	112	280,-	
		pair	40	20	12	113	468,-	
		piece	60	20	12	114	280,-	
		pair	60	20	12	115	468,-	

This product contains light devices
of energy efficiency class G

Kos.

Independent / incl. HDI



RETAIL PRICE LIST

valid



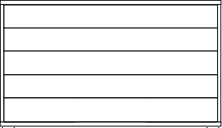

01.03.2023-31.08.2023

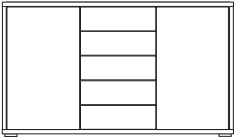
V.i.P.
by Wiemann**Chests of drawers, 86 cm high**
incl. sliding feet

All hinged-doors incl. cushioned hinges

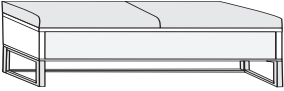
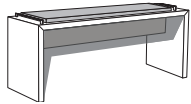
	Description	Dimensions cm			Art. no.	GBP
		W	H	D		
	Chest of drawers with 5 drawers					
	- Front glass white	60	86	43	871	718,-
	- Front glass pebble grey	60	86	43	872	718,-
	- Front glass white	80	86	43	869	788,-
	- Front glass pebble grey	80	86	43	870	788,-
	- Front glass white	141	86	43	873	1270,-
	- Front glass pebble grey	141	86	43	874	1270,-
	Dresser, 2 doors, with one full-width shelf					
	- Front glass white	80	86	43	909	618,-
	- Front glass pebble grey	80	86	43	911	618,-
	Combi dresser with 5 drawers and 2 doors					
	- Front glass white	141	86	43	920	1205,-
	- Front glass pebble grey	141	86	43	921	1205,-

Occasional furniture

Description	Dimensions cm			Art. no.	GBP
	W	H	D		
 <p>Dressing bench on angled feet in silver and one drawer with upholstered cushion</p> <p>in faux leather white</p> <ul style="list-style-type: none"> - Front glass white - Front glass pebble grey <p>in faux leather pebble grey</p> <ul style="list-style-type: none"> - Front glass white - Front glass pebble grey 	141	50	43	157	1140,-
	141	50	43	089	1140,-
	141	50	43	171	1140,-
	141	50	43	172	1140,-
	<hr/>				
	 <p>Dressing bench with upholstered faux leather cushion</p> <ul style="list-style-type: none"> - with faux leather white - with faux leather pebble grey <p> Not available in havana finish!</p>	120	53	40	176
120		53	40	111	630,-
<hr/>					
 <p>Wall mirror, lateral or vertical mounting</p>	110	85	3	086	315,-
	<hr/>				
 <p>Wall mirror</p>	60	80	3	087	168,-
	<hr/>				