

Monaco 3000.

Sliding door wardrobes.

V.i.P.
by Wiemann



Independent / incl. HDI

RETAIL PRICE LIST

valid

01.03.2023-31.08.2023



Emission Tested
Tested for Harmful
Substances
Regular Product
Surveillance

www.luv.com
ID: 1111253063



Wardrobe system Monaco.

V.i.P.
by Wiemann

Monaco 1000
Hinged-door wardrobes

Monaco 2000
Wardrobes with bi-fold doors

Monaco 1000+2000
Functional units

Monaco 3000
Sliding door wardrobes

Monaco 4000
Beds + Occasional furniture



MONACO 3000 – Free Standing Wardrobes

Wardrobe suggestions

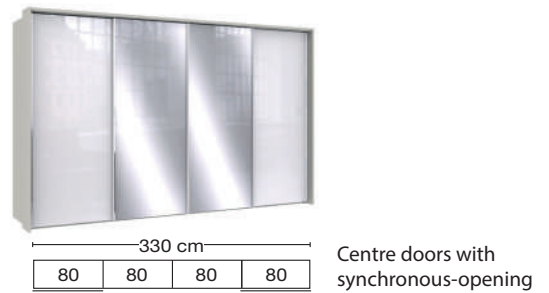
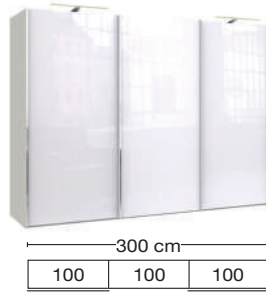

For these free standing wardrobes passepartout frames and cornices are available optionally either with our without lights (see accessories).

Wardrobe line ups (individually combined) based on MONACO 1000 + 2000 + 3000

1. Example:

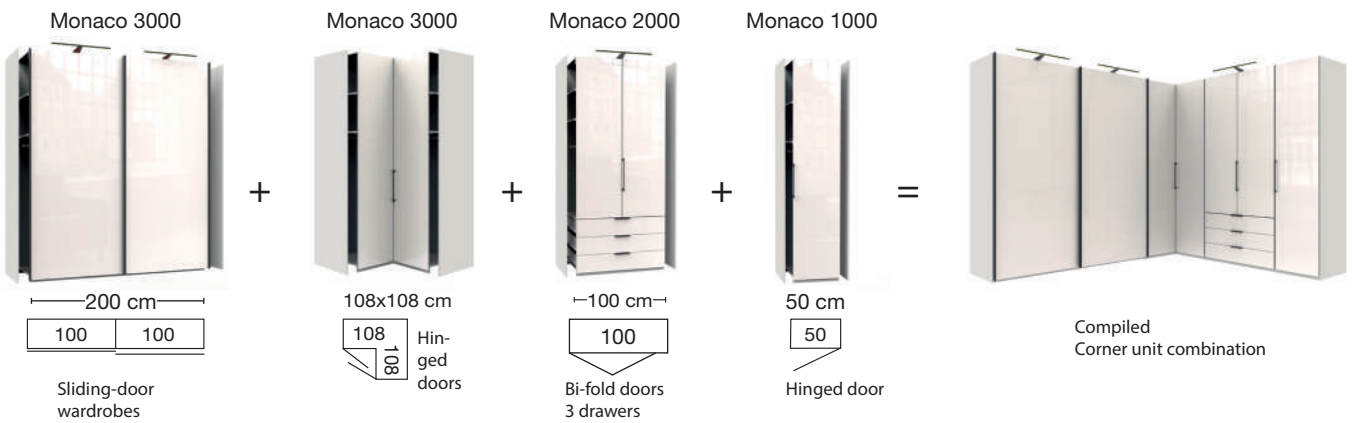

2. Example:

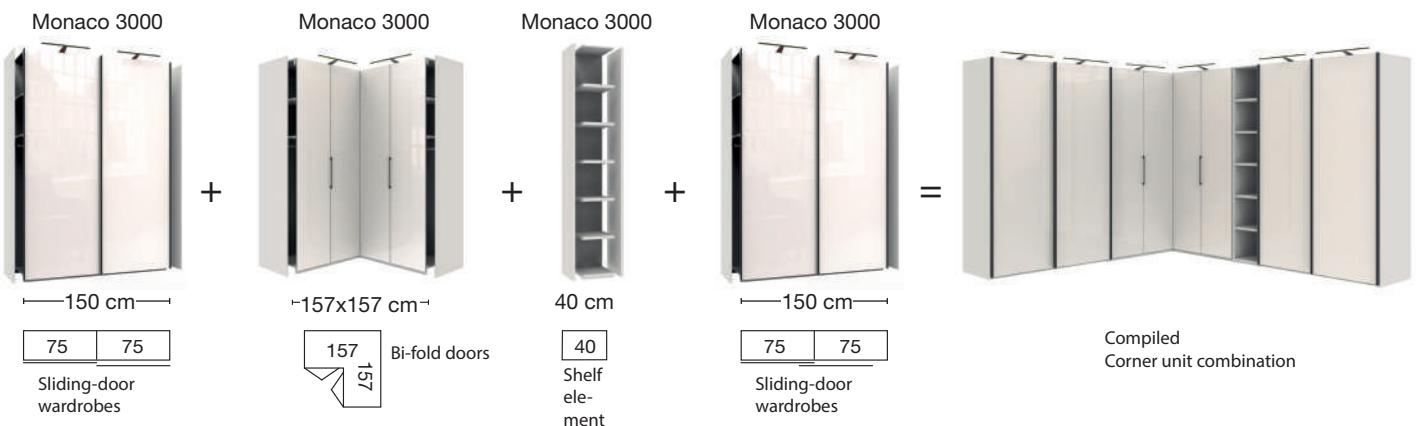

The single wardrobes include two end panels each and can get placed beside each other. Optional On-Top lights available.

Monaco 3000.

Independent / incl. HDI

RETAIL PRICE LIST

valid







01.03.2023-31.08.2023

V.i.P.
by Wiemann

Carcase and front colours

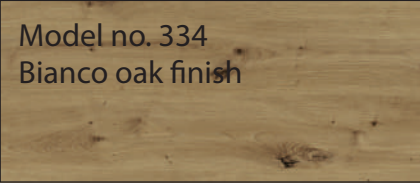
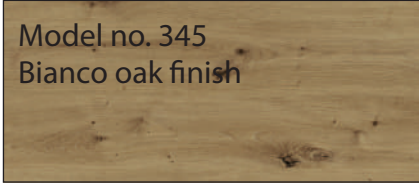
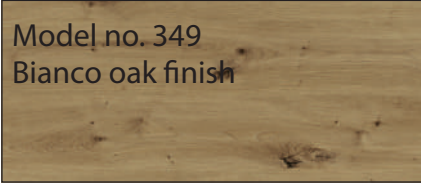
Please specify the exact colour combination of front and carcase colour for each order!

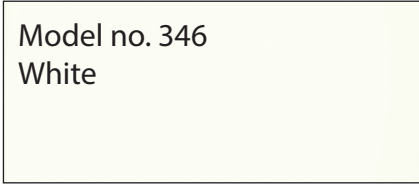
Designs:

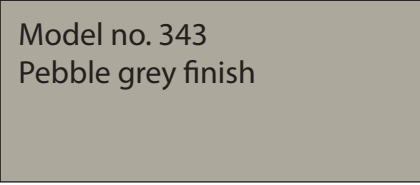
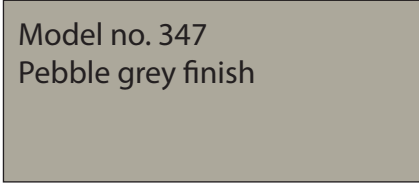
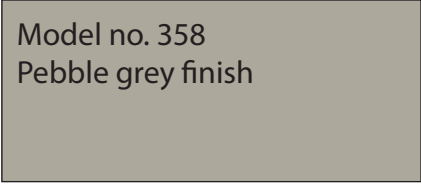
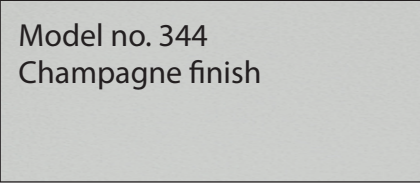
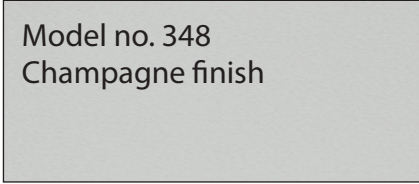
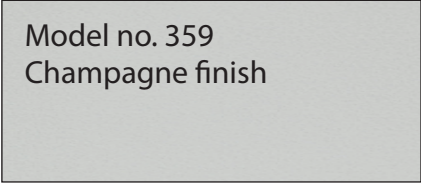
 Handles in chrome	 Handle ledges in silver	 Handles in slate finish
 Model no. 334 Bianco oak finish	 Model no. 345 Bianco oak finish	 Model no. 349 Bianco oak finish
 Model no. 342 White	 Model no. 346 White	 Model no. 357 White
 Model no. 343 Pebble grey finish	 Model no. 347 Pebble grey finish	 Model no. 358 Pebble grey finish
 Model no. 344 Champagne finish	 Model no. 348 Champagne finish	 Model no. 359 Champagne finish



Monaco 3000.

Sliding door wardrobes.

V.i.P.
by Wiemann

Front colours:

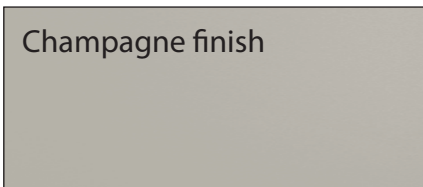
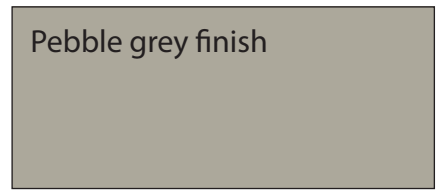
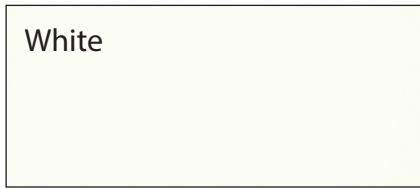

Glass fronts

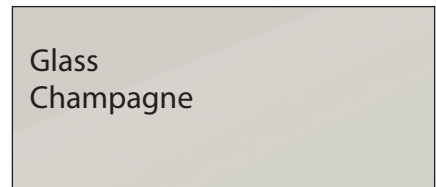
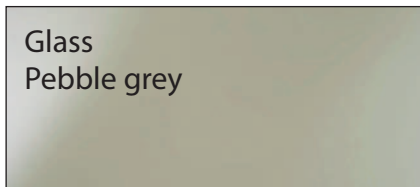

Mirror

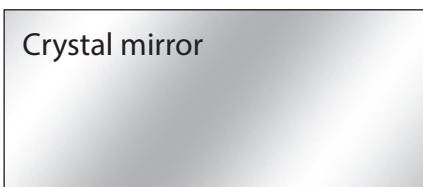

Interior colour

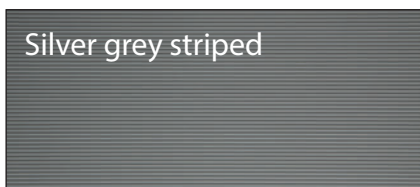

Emission Tested
Tested for Harmful
Substances
Regular Product
Surveillance

www.tuv.com
ID 1111253053

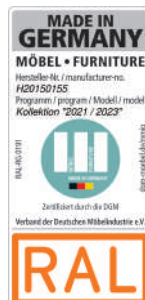

Monaco 3000.

Sliding door wardrobes.

V.i.P.
by Wiemann

Carcase width

Sliding door wardrobes

Width	Side	Plinth	Side	Plinth	Side	Plinth	Side	Plinth	Side	Width effective
150	1,5	72,2	1,5	72,2	1,5					148,9 cm
200	1,5	96,4	1,5	96,4	1,5					197,3 cm
225	1,5	72,2	1,5	72,2	1,5	72,2	1,5			222,6 cm
250	1,5	80,1	1,5	80,1	1,5	80,1	1,5			246,3 cm
280	1,5	96,4	1,5	80,1	1,5	96,4	1,5			278,9 cm
300	1,5	96,4	1,5	96,4	1,5	96,4	1,5			295,2 cm
300	1,5	72,2	1,5	72,2	1,5	72,2	1,5	72,2	1,5	296,3 cm
330	1,5	80,1	1,5	80,1	1,5	80,1	1,5	80,1	1,5	327,9 cm
400	1,5	96,4	1,5	96,4	1,5	96,4	1,5	96,4	1,5	393,1 cm

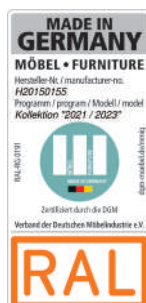
furnplanEmission Tested
Tested for Harmful
Substances
Regular Product
Surveillancewww.tuv.com
ID 1111253053

We reserve the right to color and model deviations or the correction of erroneous information. All measures are approximate cm.

Monaco 3000.

Independent / incl. HDI
 RETAIL PRICE LIST
 valid

01.03.2023-31.08.2023







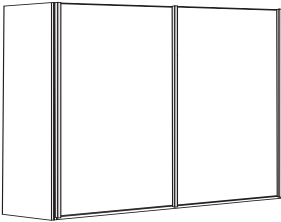





















V.i.P.
 by Wiemann

Sliding door wardrobes

Interior:
 2 adjustable shelves, 1 clothes rail

Description	Dimensions cm		Height 217 cm		Height 236 cm	
	W	D	Art. no.	GBP	Art. no.	GBP
Front in carcass colour						
 2 doors	150	67	200	1403,-	209	1453,-
2 doors	200	67	201	1503,-	210	1570,-
3 doors	225	67	202	1803,-	211	1890,-
3 doors	250	67	203	1890,-	212	1993,-
3 doors	280	67	204	2038,-	213	2150,-
3 doors	300	67	205	2085,-	214	2218,-
- with synchronous opening						
4 doors	300	67	206	2488,-	215	2620,-
4 doors	330	67	207	2520,-	216	2673,-
4 doors	400	67	208	2755,-	217	2923,-

Plinth partition

														
150 cm		200 cm		225 cm			250 cm			280 cm				
														
300 cm			300 cm				330 cm				400 cm			

Monaco 3000.





Independent / incl. HDI
 RETAIL PRICE LIST
 valid

01.03.2023-31.08.2023



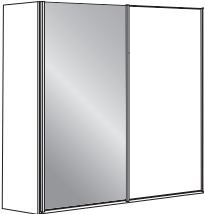
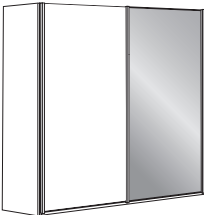
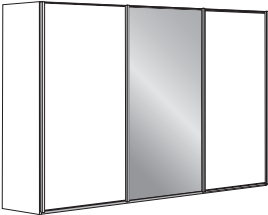
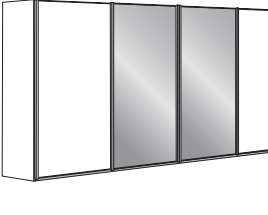

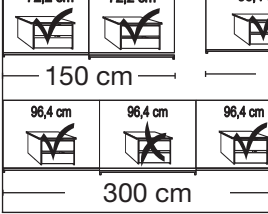























V.i.P.
 by Wiemann

Sliding door wardrobes

Interior:
 2 adjustable shelves, 1 clothes rail

Description	Dimensions cm		Height 217 cm		Height 236 cm	
	W	D	Art. no.	GBP	Art. no.	GBP
Front in carcass colour and crystal mirrored doors						
 2 doors 1 mirrored door left	150	67	218	1535,-	238	1590,-
2 doors 1 mirrored door right	150	67	219	1535,-	239	1590,-
2 doors 2 mirrored doors	150	67	220	1668,-	240	1723,-
 2 doors 1 mirrored door left	200	67	221	1668,-	241	1738,-
2 doors 1 mirrored door right	200	67	222	1668,-	242	1738,-
2 doors 2 mirrored doors	200	67	223	1838,-	243	1905,-
 3 doors 1 centre mirrored door	225	67	224	1935,-	244	2023,-
3 doors 3 mirrored doors	225	67	225	2205,-	245	2293,-
 3 doors 1 centre mirrored door	250	67	226	2038,-	246	2140,-
3 doors 3 mirrored doors	250	67	227	2338,-	247	2438,-
 3 doors 1 centre mirrored door	280	67	228	2185,-	248	2305,-
3 doors 3 mirrored doors	280	67	229	2520,-	249	2640,-
 3 doors 1 centre mirrored door	300	67	230	2250,-	250	2388,-
3 doors 3 mirrored doors	300	67	231	2585,-	251	2720,-
- with synchronous opening						
 4 doors 2 centre mirrored doors	300	67	232	2740,-	252	2888,-
4 doors 4 mirrored doors	300	67	233	3020,-	253	3155,-
4 doors 2 centre mirrored doors	330	67	234	2823,-	254	2975,-
4 doors 4 mirrored doors	330	67	235	3123,-	255	3278,-
4 doors 2 centre mirrored doors	400	67	236	3090,-	256	3255,-
4 doors 4 mirrored doors	400	67	237	3423,-	257	3590,-

Plinth partition

 72,2 cm	 72,2 cm	 96,4 cm	 96,4 cm	 72,2 cm	 72,2 cm	 72,2 cm	 80,1 cm	 80,1 cm	 80,1 cm	 96,4 cm	 80,1 cm	 96,4 cm		
150 cm		200 cm		225 cm			250 cm			280 cm				
 96,4 cm	 96,4 cm	 96,4 cm	 72,2 cm	 72,2 cm	 72,2 cm	 72,2 cm	 80,1 cm	 80,1 cm	 80,1 cm	 80,1 cm	 96,4 cm	 96,4 cm	 96,4 cm	 96,4 cm
300 cm			300 cm				330 cm				400 cm			

Monaco 3000.

Independent / incl. HDI

RETAIL PRICE LIST

valid

01.03.2023-31.08.2023

V.i.P.
by Wiemann

Sliding door wardrobes

Interior:
2 adjustable shelves, 1 clothes rail

Description	Dimensions cm		Height 217 cm		Height 236 cm			
	W	D	Art. no.	GBP	Art. no.	GBP		
Glass doors in white in combination with doors in carcass colour								
	2 doors	1 glass door left	150	67	258	1535,-	278	1590,-
	2 doors	1 glass door right	150	67	259	1535,-	279	1590,-
	2 doors	2 glass doors	150	67	260	1668,-	280	1723,-
	2 doors	1 glass door left	200	67	261	1668,-	281	1738,-
	2 doors	1 glass door right	200	67	262	1668,-	282	1738,-
	2 doors	2 glass doors	200	67	263	1838,-	283	1905,-
	3 doors	1 centre glass door	225	67	264	1935,-	284	2023,-
	3 doors	3 glass doors	225	67	265	2205,-	285	2293,-
	3 doors	1 centre glass door	250	67	266	2038,-	286	2140,-
	3 doors	3 glass doors	250	67	267	2338,-	287	2438,-
	3 doors	1 centre glass door	280	67	268	2185,-	288	2305,-
	3 doors	3 glass doors	280	67	269	2520,-	289	2640,-
	3 doors	1 centre glass door	300	67	270	2250,-	290	2388,-
	3 doors	3 glass doors	300	67	271	2585,-	291	2720,-
	- with synchronous opening							
	4 doors	2 centre glass doors	300	67	272	2740,-	292	2888,-
	4 doors	4 glass doors	300	67	273	3020,-	293	3155,-
	4 doors	2 centre glass doors	330	67	274	2823,-	294	2975,-
	4 doors	4 glass doors	330	67	275	3123,-	295	3278,-
	4 doors	2 centre glass doors	400	67	276	3090,-	296	3255,-
	4 doors	4 glass doors	400	67	277	3423,-	297	3590,-

Plinth partition

72,2 cm	72,2 cm	96,4 cm	96,4 cm	72,2 cm	72,2 cm	72,2 cm	80,1 cm	80,1 cm	80,1 cm	96,4 cm	80,1 cm	96,4 cm		
150 cm		200 cm		225 cm			250 cm			280 cm				
96,4 cm	96,4 cm	96,4 cm	96,4 cm	72,2 cm	72,2 cm	72,2 cm	80,1 cm	80,1 cm	80,1 cm	80,1 cm	96,4 cm	96,4 cm	96,4 cm	96,4 cm
300 cm			300 cm				330 cm				400 cm			

Monaco 3000.

Independent / incl. HDI

RETAIL PRICE LIST

valid

01.03.2023-31.08.2023



V.i.P.

by Wiemann





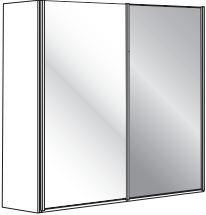

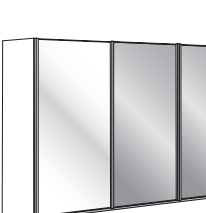
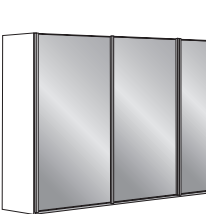
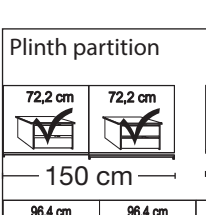
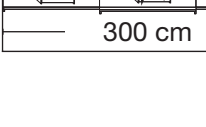





















Sliding door wardrobes

Interior:

2 adjustable shelves, 1 clothes rail

Description	Dimensions cm		Height 217 cm		Height 236 cm	
	W	D	Art. no.	GBP	Art. no.	GBP
Glass doors in white and crystal mirrored doors						
 2 doors 1 mirrored door left	150	67	298	1668,-	318	1723,-
2 doors 1 mirrored door right	150	67	299	1668,-	319	1723,-
2 doors 2 mirrored doors	150	67	300	1668,-	320	1723,-
 2 doors 1 mirrored door left	200	67	301	1838,-	321	1905,-
2 doors 1 mirrored door right	200	67	302	1838,-	322	1905,-
2 doors 2 mirrored doors	200	67	303	1838,-	323	1905,-
 3 doors 1 centre mirrored door	225	67	304	2205,-	324	2293,-
3 doors 3 mirrored doors	225	67	305	2205,-	325	2293,-
 3 doors 1 centre mirrored door	250	67	306	2338,-	326	2438,-
3 doors 3 mirrored doors	250	67	307	2338,-	327	2438,-
 3 doors 1 centre mirrored door	280	67	308	2520,-	328	2640,-
3 doors 3 mirrored doors	280	67	309	2520,-	329	2640,-
 3 doors 1 centre mirrored door	300	67	310	2585,-	330	2720,-
3 doors 3 mirrored doors	300	67	311	2585,-	331	2720,-
- with synchronous opening						
 4 doors 2 centre mirrored doors	300	67	312	3020,-	332	3155,-
4 doors 4 mirrored doors	300	67	313	3020,-	333	3155,-
4 doors 2 centre mirrored doors	330	67	314	3123,-	334	3278,-
4 doors 4 mirrored doors	330	67	315	3123,-	335	3278,-
4 doors 2 centre mirrored doors	400	67	316	3423,-	336	3590,-
4 doors 4 mirrored doors	400	67	317	3423,-	337	3590,-

Plinth partition

														
150 cm		200 cm		225 cm			250 cm			280 cm				
														
300 cm			300 cm				330 cm				400 cm			

Monaco 3000.

Independent / incl. HDI

RETAIL PRICE LIST

valid

01.03.2023-31.08.2023

V.i.P.







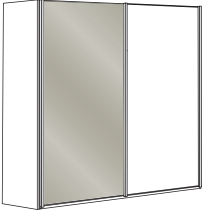
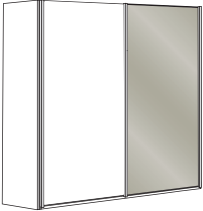
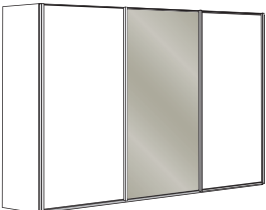
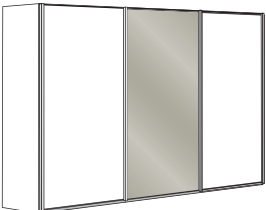
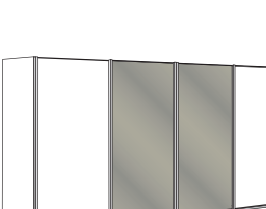
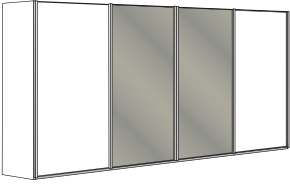
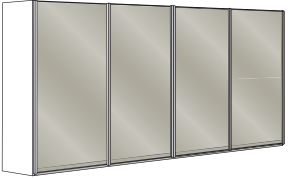























by Wiemann

Sliding door wardrobes

Interior:
2 adjustable shelves, 1 clothes rail

Description	Dimensions cm		Height 217 cm		Height 236 cm			
	W	D	Art. no.	GBP	Art. no.	GBP		
	2 doors	1 glass door left	150	67	338	1535,-	358	1590,-
	2 doors	1 glass door right	150	67	339	1535,-	359	1590,-
	2 doors	2 glass doors	150	67	340	1668,-	360	1723,-
	2 doors	1 glass door left	200	67	341	1668,-	361	1738,-
	2 doors	1 glass door right	200	67	342	1668,-	362	1738,-
	2 doors	2 glass doors	200	67	343	1838,-	563	1905,-
	3 doors	1 centre glass door	225	67	344	1935,-	564	2023,-
	3 doors	3 glass doors	225	67	345	2205,-	565	2293,-
	3 doors	1 centre glass door	250	67	346	2038,-	366	2140,-
	3 doors	3 glass doors	250	67	347	2338,-	367	2438,-
	3 doors	1 centre glass door	280	67	348	2185,-	368	2305,-
	3 doors	3 glass doors	280	67	349	2520,-	569	2640,-
	3 doors	1 centre glass door	300	67	350	2250,-	570	2388,-
	3 doors	3 glass doors	300	67	351	2585,-	371	2720,-
	- with synchronous opening							
	4 doors	2 centre glass doors	300	67	352	2740,-	372	2888,-
	4 doors	4 glass doors	300	67	353	3020,-	373	3155,-
	4 doors	2 centre glass doors	330	67	354	2823,-	374	2975,-
	4 doors	4 glass doors	330	67	355	3123,-	375	3278,-
	4 doors	2 centre glass doors	400	67	356	3090,-	376	3255,-
	4 doors	4 glass doors	400	67	357	3423,-	377	3590,-

Plinth partition

														
72,2 cm	72,2 cm	96,4 cm	96,4 cm	72,2 cm	72,2 cm	72,2 cm	72,2 cm	80,1 cm	80,1 cm	80,1 cm	96,4 cm	80,1 cm	96,4 cm	
150 cm		200 cm		225 cm			250 cm			280 cm				
														
96,4 cm	96,4 cm	96,4 cm	72,2 cm	72,2 cm	72,2 cm	72,2 cm	80,1 cm	80,1 cm	80,1 cm	80,1 cm	96,4 cm	96,4 cm	96,4 cm	96,4 cm
300 cm			300 cm				330 cm				400 cm			

Monaco 3000.

Independent / incl. HDI

RETAIL PRICE LIST



valid

01.03.2023-31.08.2023

V.i.P.
by Wiemann

Sliding door wardrobes

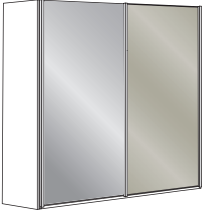
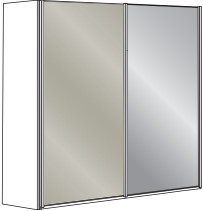
Interior:
2 adjustable shelves, 1 clothes rail

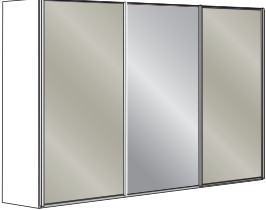
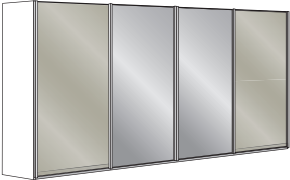
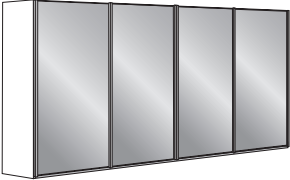
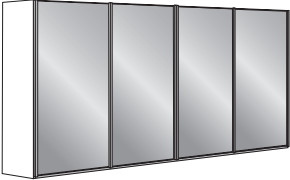
Description	Dimensions cm		Height 217 cm		Height 236 cm		
	W	D	Art. no.	GBP	Art. no.	GBP	
 Glass doors in pebble grey and crystal mirrored doors	2 doors 1 mirrored door left	150	67	378	1668,-	398	1723,-
	2 doors 1 mirrored door right	150	67	379	1668,-	399	1723,-
	2 doors 2 mirrored doors	150	67	380	1668,-	400	1723,-
	2 doors 1 mirrored door left	200	67	381	1838,-	401	1905,-
	2 doors 1 mirrored door right	200	67	382	1838,-	402	1905,-
	2 doors 2 mirrored doors	200	67	383	1838,-	403	1905,-
	3 doors 1 centre mirrored door	225	67	384	2205,-	404	2293,-
	3 doors 3 mirrored doors	225	67	385	2205,-	405	2293,-
	3 doors 1 centre mirrored door	250	67	386	2338,-	406	2438,-
	3 doors 3 mirrored doors	250	67	387	2338,-	407	2438,-
	3 doors 1 centre mirrored door	280	67	388	2520,-	408	2640,-
	3 doors 3 mirrored doors	280	67	389	2520,-	409	2640,-
	3 doors 1 centre mirrored door	300	67	390	2585,-	410	2720,-
	3 doors 3 mirrored doors	300	67	391	2585,-	411	2720,-
	- with synchronous opening						
	4 doors 2 centre mirrored doors	300	67	392	3020,-	412	3155,-
	4 doors 4 mirrored doors	300	67	393	3020,-	413	3155,-
	4 doors 2 centre mirrored doors	330	67	394	3123,-	414	3278,-
	4 doors 4 mirrored doors	330	67	395	3123,-	415	3278,-
	4 doors 2 centre mirrored doors	400	67	396	3423,-	416	3590,-
	4 doors 4 mirrored doors	400	67	397	3423,-	417	3590,-

Plinth partition

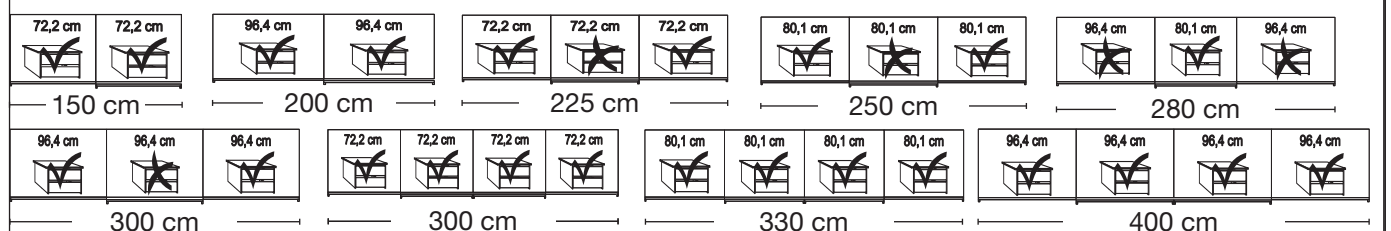

Monaco 3000.

Independent / incl. HDI

RETAIL PRICE LIST

valid

01.03.2023-31.08.2023

V.i.P.







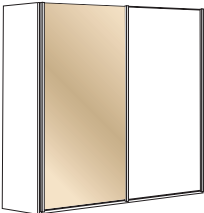
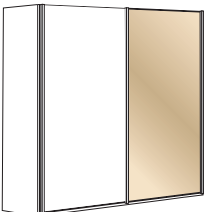
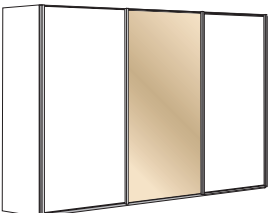
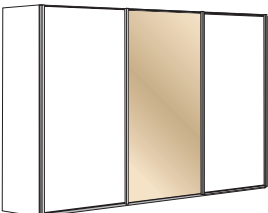
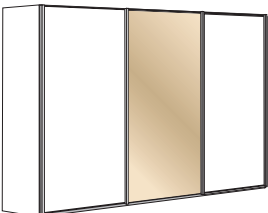
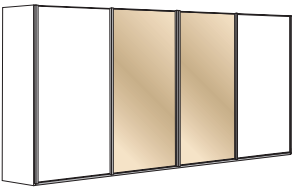
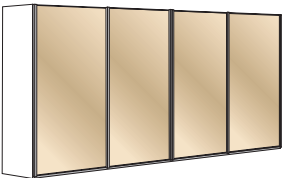























by Wiemann

Sliding door wardrobes

Interior:
2 adjustable shelves, 1 clothes rail

Description	Dimensions cm		Height 217 cm		Height 236 cm			
	W	D	Art. no.	GBP	Art. no.	GBP		
 Glass doors in champagne in combination with doors in carcass colour	2 doors	1 glass door left	150	67	418	1535,-	438	1590,-
	2 doors	1 glass door right	150	67	419	1535,-	439	1590,-
	2 doors	2 glass doors	150	67	420	1668,-	440	1723,-
	2 doors	1 glass door left	200	67	421	1668,-	441	1738,-
	2 doors	1 glass door right	200	67	422	1668,-	442	1738,-
	2 doors	2 glass doors	200	67	423	1838,-	443	1905,-
	3 doors	1 centre glass door	225	67	424	1935,-	444	2023,-
	3 doors	3 glass doors	225	67	425	2205,-	445	2293,-
	3 doors	1 centre glass door	250	67	426	2038,-	446	2140,-
	3 doors	3 glass doors	250	67	427	2338,-	447	2438,-
	3 doors	1 centre glass door	280	67	428	2185,-	448	2305,-
	3 doors	3 glass doors	280	67	429	2520,-	449	2640,-
	3 doors	1 centre glass door	300	67	430	2250,-	450	2388,-
	3 doors	3 glass doors	300	67	431	2585,-	451	2720,-
	- with synchronous opening							
	4 doors	2 centre glass doors	300	67	432	2740,-	452	2888,-
	4 doors	4 glass doors	300	67	433	3020,-	453	3155,-
	4 doors	2 centre glass doors	330	67	434	2823,-	454	2975,-
	4 doors	4 glass doors	330	67	435	3123,-	455	3278,-
	4 doors	2 centre glass doors	400	67	436	3090,-	456	3255,-
	4 doors	4 glass doors	400	67	437	3423,-	457	3590,-

Plinth partition

														
72,2 cm	72,2 cm	96,4 cm	96,4 cm	72,2 cm	72,2 cm	72,2 cm	72,2 cm	80,1 cm	80,1 cm	80,1 cm	96,4 cm	80,1 cm	96,4 cm	
150 cm		200 cm		225 cm			250 cm			280 cm				
														
96,4 cm	96,4 cm	96,4 cm	72,2 cm	72,2 cm	72,2 cm	72,2 cm	80,1 cm	80,1 cm	80,1 cm	80,1 cm	96,4 cm	96,4 cm	96,4 cm	96,4 cm
300 cm			300 cm				330 cm				400 cm			

Monaco 3000.

Independent / incl. HDI

RETAIL PRICE LIST





valid

01.03.2023-31.08.2023



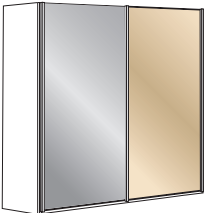
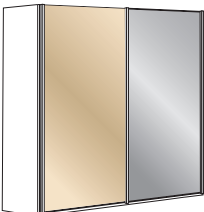
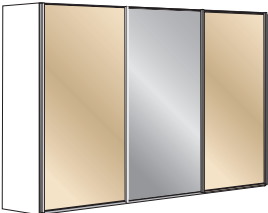
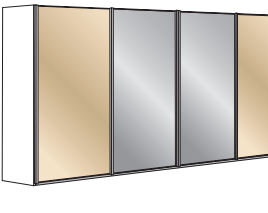

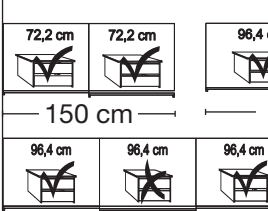























V.i.P.
by Wiemann

Sliding door wardrobes

Interior:
2 adjustable shelves, 1 clothes rail

Description	Dimensions cm		Height 217 cm		Height 236 cm	
	W	D	Art. no.	GBP	Art. no.	GBP
Glass doors in champagne and crystal mirrored doors						
 2 doors 1 mirrored door left	150	67	458	1668,-	478	1723,-
2 doors 1 mirrored door right	150	67	459	1668,-	479	1723,-
2 doors 2 mirrored doors	150	67	460	1668,-	480	1723,-
 2 doors 1 mirrored door left	200	67	461	1838,-	481	1905,-
2 doors 1 mirrored door right	200	67	462	1838,-	482	1905,-
2 doors 2 mirrored doors	200	67	463	1838,-	483	1905,-
 3 doors 1 centre mirrored door	225	67	464	2205,-	484	2293,-
3 doors 3 mirrored doors	225	67	465	2205,-	485	2293,-
 3 doors 1 centre mirrored door	250	67	466	2338,-	486	2438,-
3 doors 3 mirrored doors	250	67	467	2338,-	487	2438,-
 3 doors 1 centre mirrored door	280	67	468	2520,-	488	2640,-
3 doors 3 mirrored doors	280	67	469	2520,-	489	2640,-
 3 doors 1 centre mirrored door	300	67	470	2585,-	490	2720,-
3 doors 3 mirrored doors	300	67	471	2585,-	491	2720,-
- with synchronous opening						
 4 doors 2 centre mirrored doors	300	67	472	3020,-	492	3155,-
4 doors 4 mirrored doors	300	67	473	3020,-	493	3155,-
4 doors 2 centre mirrored doors	330	67	474	3123,-	494	3278,-
4 doors 4 mirrored doors	330	67	475	3123,-	495	3278,-
4 doors 2 centre mirrored doors	400	67	476	3423,-	496	3590,-
4 doors 4 mirrored doors	400	67	477	3423,-	497	3590,-

Plinth partition

 72,2 cm	 72,2 cm	 96,4 cm	 96,4 cm	 72,2 cm	 72,2 cm	 72,2 cm	 72,2 cm	 80,1 cm	 80,1 cm	 80,1 cm	 96,4 cm	 80,1 cm	 96,4 cm	
150 cm		200 cm		225 cm				250 cm			280 cm			
 96,4 cm	 96,4 cm	 96,4 cm	 72,2 cm	 72,2 cm	 72,2 cm	 72,2 cm	 80,1 cm	 80,1 cm	 80,1 cm	 80,1 cm	 96,4 cm	 96,4 cm	 96,4 cm	 96,4 cm
300 cm			300 cm				330 cm				400 cm			

Monaco 3000.

Independent / incl. HDI

RETAIL PRICE LIST

valid



01.03.2023-31.08.2023

V.i.P.
by Wiemann

Corner units without cornice

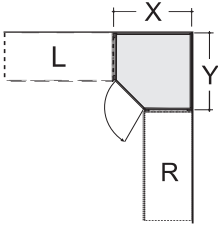
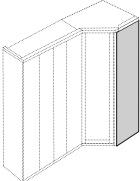

In combination with sliding door wardrobes, no cornices or passepartout frames are possible!

Description	Dimensions cm		Height 216 cm		Height 236 cm				
	W	D	Art. no.	GBP	Art. no.	GBP			
   <p>Layout (plan view) see page 19/20</p> <p>Interior: 2 shelves, 1 clothes rail per compartment All hinged-doors incl. cushioned hinges</p>	Extended corner unit								
	Door hinged left:								
	1 door	- Front in carcass colour		93	93	774	1020,-	779	1075,-
	1 door	- Front glass white		93	93	775	1088,-	780	1140,-
	1 door	- Front glass pebble grey		93	93	776	1088,-	781	1140,-
	1 door	- Front glass champagne		93	93	777	1088,-	782	1140,-
	1 door	- Front crystal mirror		93	93	778	1088,-	783	1140,-
	Door hinged right:								
	1 door	- Front in carcass colour		93	93	784	1020,-	789	1075,-
	1 door	- Front glass white		93	93	785	1088,-	790	1140,-
1 door	- Front glass pebble grey		93	93	786	1088,-	791	1140,-	
1 door	- Front glass champagne		93	93	787	1088,-	792	1140,-	
1 door	- Front crystal mirror		93	93	788	1088,-	793	1140,-	
 <p>End panel for extended corner unit, can be used on right and left</p> <p>Required with a final extended corner unit. If a corner unit stands separately, 2 outer sides are required.</p>	56	1,5	090	130,-	091	148,-			

Not useable in conjunction with cornices!

Monaco 3000.

Independent / incl. HDI

RETAIL PRICE LIST

valid



01.03.2023-31.08.2023

V.i.P.
by Wiemann

Corner units without cornice

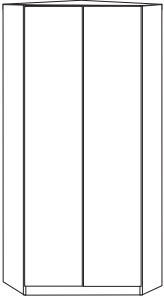

In combination with sliding door wardrobes, no cornices or passepartout frames are possible!

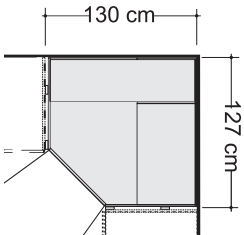
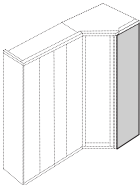
Description	Dimensions cm		Height 216 cm		Height 236 cm	
	W	D	Art. no.	GBP	Art. no.	GBP
 <p>Walk-in corner unit with hinged doors</p> <p>2 doors - Front in carcase colour</p> <p>2 doors - Front glass white</p> <p>2 doors - Front glass pebble grey</p> <p>2 doors - Front glass champagne</p> <p>2 doors - Front crystal mirror</p> <p>Layout (plan view) see page 19/20</p>   <p>Interior: W 72.2cm: 2 shelves, 1 hanging rail, W 125 cm: 5 shelves, Lights with motion detector</p> <p>All hinged-doors incl. cushioned hinges</p> <p>This product contains a light device of energy efficiency class G</p>						
	130	127	799	1673,-	809	1775,-
	130	127	800	1743,-	810	1840,-
	130	127	801	1743,-	811	1840,-
	130	127	802	1743,-	812	1840,-
	130	127	803	1743,-	813	1840,-
 <p>End panel for walk-in corner unit, can be used on right and left</p> <p>Required if a corner unit is used on end. If a corner unit is mounted separately, 2 outer panels are required.</p> <p>Not useable in conjunction with cornices!</p>	56	1,5	090	130,-	091	148,-

Monaco 3000.

Independent / incl. HDI

RETAIL PRICE LIST

valid





01.03.2023-31.08.2023

V.i.P.
by Wiemann

Corner units without cornice

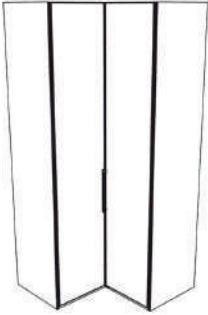

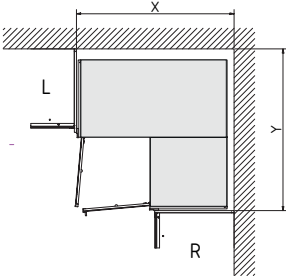
In combination with sliding door wardrobes, no cornices or passepartout frames are possible!

Description	Dimensions cm		Height 216 cm		Height 236 cm	
	W	D	Art. no.	GBP	Art. no.	GBP
 <p>Corner unit, 90 degree with hinged doors</p> <ul style="list-style-type: none"> - Front in carcass colour - Front glass white - Front glass pebble grey - Front glass champagne - Front crystal mirror 	108	108	968	1360,-	992	1430,-
	108	108	969	1530,-	993	1598,-
	108	108	989	1530,-	994	1598,-
	108	108	990	1530,-	995	1598,-
	108	108	991	1530,-	996	1598,-
						
 <p>Layout (plan view) see page 19/20</p>						
<p>Interior: 2 shelves 105cm x 105cm, 2 hanging rails 71.5 cm</p>						
 <p>Doors without cushioners!</p>						

Monaco 3000.

Independent / incl. HDI

RETAIL PRICE LIST

valid



01.03.2023-31.08.2023

V.i.P.
by Wiemann

Corner units without cornice

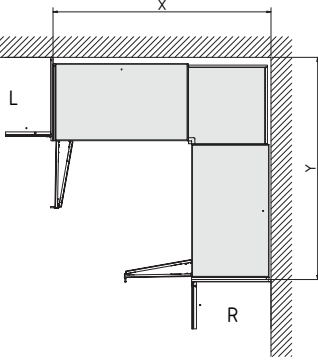

In combination with sliding door wardrobes, no cornices or passepartout frames are possible!

Description	Dimensions cm		Height 216 cm		Height 236 cm	
	W	D	Art. no.	GBP	Art. no.	GBP
 <p>Corner unit, 90 degree with bi-fold doors</p> <ul style="list-style-type: none"> - Front in carcase colour - Front glass white - Front glass pebble grey - Front glass champagne - Front crystal mirror 	157	157	814	1930,-	819	2030,-
	157	157	815	2268,-	820	2365,-
	157	157	816	2268,-	821	2365,-
	157	157	817	2268,-	822	2365,-
	157	157	818	2268,-	823	2365,-
						
						
<p>Interior:</p> <p>W 55.8 cm: 2 shelves</p> <p>W 96.4 cm: 4 shelves</p> <p>2 hanging rails 152 cm</p>						

Monaco 3000.

Independent / incl. HDI
 RETAIL PRICE LIST
 valid

01.03.2023-31.08.2023

V.i.P.
 by Wiemann

Size over view for corner robe

Due to different depth dimensions
 there are different space requirements:

Wardrobe Side L	Wardrobe Side R	Required space for extended corner unit
Hinged-/ Bi-fold-wardrobe, Shelf element	Sliding-door wardrobe, 2-4 doors	X = 98,0 cm Y = 94,2 cm
Sliding-door wardrobe, 2 doors	Hinged-/ Bi-fold-wardrobe, Shelf element	X = 94,2 cm Y = 101,0 cm
Sliding-door wardrobe, 3-4 doors	Hinged-/ Bi-fold-wardrobe, Shelf element	X = 94,2 cm Y = 98,0 cm
Sliding-door wardrobe, 2 doors	Sliding-door wardrobe, 2-4 doors	X = 99,2 cm Y = 102,2 cm
Sliding-door wardrobe, 3-4 doors	Sliding-door wardrobe, 2-4 doors	X = 99,2 cm Y = 99,2 cm



Extended corner unit

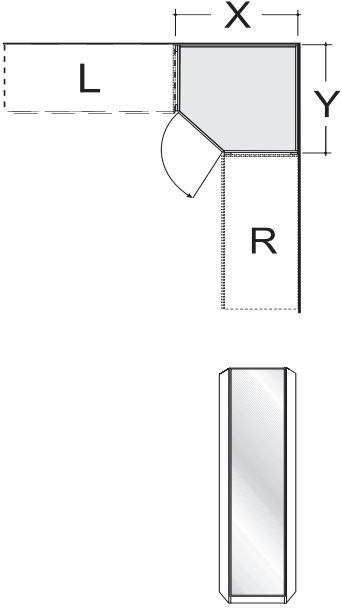

Wardrobe Side L	Wardrobe Side R	Required space for walk-in corner unit
Hinged-/ Bi-fold-wardrobe, Shelf element	Sliding-door wardrobe, 2-4 doors	X = 134,4 cm Y = 126,9 cm
Sliding-door wardrobe, 2 doors	Hinged-/ Bi-fold-wardrobe, Shelf element	X = 130,6 cm Y = 134,2 cm
Sliding-door wardrobe, 3-4 doors	Hinged-/ Bi-fold-wardrobe, Shelf element	X = 130,6 cm Y = 131,2 cm
Sliding-door wardrobe, 2 doors	Sliding-door wardrobe, 2-4 doors	X = 135,6 cm Y = 135,4 cm
Sliding-door wardrobe, 3-4 doors	Sliding-door wardrobe, 2-4 doors	X = 135,6 cm Y = 132,4 cm



Walk-in corner unit with hinged doors

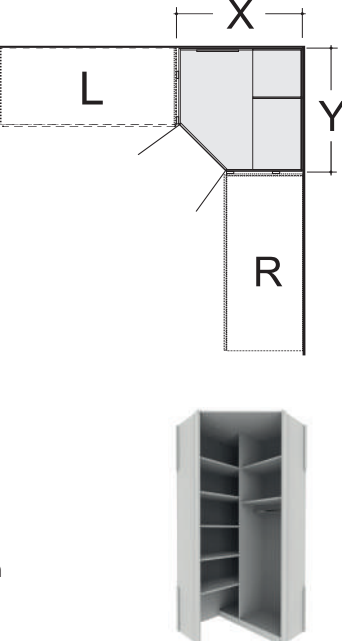

Monaco 3000.

Independent / incl. HDI
 RETAIL PRICE LIST
 valid

01.03.2023-31.08.2023

V.i.P.
 by Wiemann

Size over view for corner robe

Due to different depth dimensions
 there are different space requirements:

Wardrobe Side L	Wardrobe Side R	Required space for 90 degree corner unit with hinged door	
Hinged-/ Bi-fold-wardrobe, Shelf element	Sliding-door wardrobe, 2-4 doors	X = 114,2 cm Y = 107,9 cm	
Sliding-door wardrobe, 2 doors	Hinged-/ Bi-fold-wardrobe, Shelf element	X = 107,9 cm Y = 117,2 cm	
Sliding-door wardrobe, 3-4 doors	Hinged-/ Bi-fold-wardrobe, Shelf element	X = 107,9 cm Y = 114,2 cm	
Sliding-door wardrobe, 2 doors	Sliding-door wardrobe, 2-4 doors	X = 114,2 cm Y = 117,2 cm	
Sliding-door wardrobe, 3-4 doors	Sliding-door wardrobe, 2-4 doors	X = 114,2 cm Y = 114,2 cm	



Corner unit, 90 degree with hinged-doors

Wardrobe Side L	Wardrobe Side R	Required space for 90 degree corner unit with bi-fold door	
Hinged-/ Bi-fold-wardrobe, Shelf element	Sliding-door wardrobe, 2-4 doors	X = 158,0 cm Y = 156,5 cm	
Sliding-door wardrobe, 2 doors	Hinged-/ Bi-fold-wardrobe, Shelf element	X = 156,5 cm Y = 161,0 cm	
Sliding-door wardrobe, 3-4 doors	Hinged-/ Bi-fold-wardrobe, Shelf element	X = 156,5 cm Y = 158,0 cm	
Sliding-door wardrobe, 2 doors	Sliding-door wardrobe, 2-4 doors	X = 158,0 cm Y = 161,0 cm	
Sliding-door wardrobe, 3-4 doors	Sliding-door wardrobe, 2-4 doors	X = 158,0 cm Y = 158,0 cm	



Corner unit, 90 degree with bi-fold-doors

Monaco 3000.

Independent / incl. HDI

RETAIL PRICE LIST

valid

01.03.2023-31.08.2023

V.i.P.
by Wiemann

Shelf element without cornice

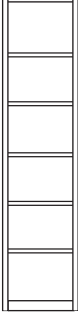

Not for use in conjunction with passepartout-frames and cornices!

Description	Dimensions cm		Height 216 cm		Height 236 cm	
	W	D	Art. no.	GBP	Art. no.	GBP
 <p>Open shelf element in carcass colour, with 5 shelves</p>	40	36	840	718,-	841	738,-

Monaco 3000.

Independent / incl. HDI



RETAIL PRICE LIST

valid







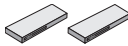

01.03.2023-31.08.2023

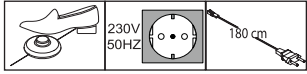
V.i.P.
by Wiemann

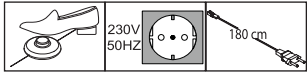
Unit accessories

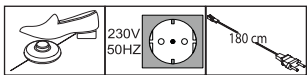
	Description	Dimensions cm			Art. no.	GBP
		W	H	D		
	Bumper					
	- for 2-doors wardrobes 1 item Optimal functioning only in combination with self-closing mechanism for outer doors - for 3-4 door wardrobes 2 items Best performance in conjunction with soft closing mechanism!	28	4	2	369	63,-
		28	4	2	370	95,-
	Soft-closing mechanism for middle doors					
	- for 3-door units * piece - for 4-door units piece	24	2	11	363	115,-
		24	2	11	364	150,-
	 * Please pay attention to clearance between wardrobe and ceiling! To be fitted from top of the wardrobe!					
	2-piece set self-closing mechanism with buffering for outer doors, Set for 2-,3- and 4-doors					
	pair	24	2	11	365	150,-

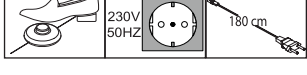
Unit accessories

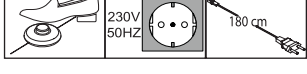
	Description	Dimensions cm			Art. no.	GBP
		W	H	D		
 <p>This product contains light devices of energy efficiency class E</p> 	LED Clip-On-Lights, silver					
	1 item	60	1,5	4,5	980	173,-
	2 items	60	1,5	4,5	981	248,-
	3 items	60	1,5	4,5	982	320,-
	 Only in conjunction with PPT-Frame and cornice!					
 <p>This product contains light devices of energy efficiency class E</p> 	LED line light, silver					
	1 item	60	6	19	983	173,-
	2 items	60	6	19	984	248,-
	3 items	60	6	19	985	320,-
 <p>This product contains light devices of energy efficiency class E</p> 	LED Clip-On-Lights, black					
	1 item	60	1,5	4,5	880	173,-
	2 items	60	1,5	4,5	881	248,-
	3 items	60	1,5	4,5	882	320,-
	 Only in conjunction with PPT-Frame and cornice!					
 <p>This product contains light devices of energy efficiency class E</p> 	LED line light, black					
	1 item	60	6	19	883	173,-
	2 items	60	6	19	884	248,-
	3 items	60	6	19	885	320,-
 <p>This product contains light devices of energy efficiency class F</p> 	LED top light, chrome					
	1 item	5,5	3	22,5	970	173,-
	2 items	5,5	3	22,5	971	248,-
	3 items	5,5	3	22,5	972	320,-

Monaco 3000.

Independent / incl. HDI



RETAIL PRICE LIST

valid

01.03.2023-31.08.2023

V.i.P.
by Wiemann

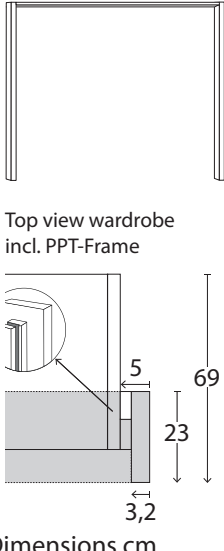
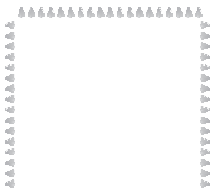
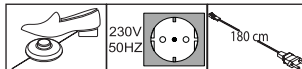
Passe-partout frames for sliding door wardrobes with or without lights

Description	Dimensions cm		Height 221 cm		Height 240 cm	
	W	D	Art. no.	GBP	Art. no.	GBP
 <p>Top view wardrobe incl. PPT-Frame</p> <p>Dimensions cm</p> <p>Passe-partout frame, Width per side profile 3.2 cm, without lights</p> <ul style="list-style-type: none"> - for width 150 cm - for width 200 cm - for width 225 cm - for width 250 cm - for width 280 cm - for width 300 cm ⚠ - only for 3-doors wardrobes - for width 300 cm ⚠ - only for 4-doors wardrobes - for width 330 cm - for width 400 cm 	160	23	700	288,-	709	325,-
	210	23	701	300,-	710	335,-
	235	23	702	303,-	711	338,-
	260	23	703	308,-	712	345,-
	290	23	704	310,-	713	348,-
	310	23	705	315,-	714	355,-
	310	23	706	315,-	715	355,-
	340	23	707	435,-	716	473,-
	410	23	708	443,-	717	483,-
	 <p>Surcharge for circumferential LED illumination (optional):</p> <ul style="list-style-type: none"> - for width 150 cm - for width 200 cm - for width 225 cm - for width 250 cm - for width 280 cm - for width 300 cm ⚠ - only for 3-doors wardrobes - for width 300 cm ⚠ - only for 4-doors wardrobes - for width 330 cm - for width 400 cm 	160	23	737	658,-	746
210		23	738	670,-	747	685,-
235		23	739	673,-	748	688,-
260		23	740	673,-	749	688,-
290		23	741	680,-	750	695,-
310		23	742	685,-	751	703,-
310		23	743	685,-	752	703,-
340		23	744	700,-	753	715,-
410		23	745	725,-	754	743,-
<p>This product contains light devices of energy efficiency class F</p> 						
 <p>Can not get assembled retrospectively!</p>						



Please note:

Passe-partout frame increases the wardrobe width to the dimensions indicated.

Monaco 3000.

Independent / incl. HDI

RETAIL PRICE LIST

valid

01.03.2023-31.08.2023

V.i.P.
by Wiemann

Passe-partout frames for sliding door wardrobes with or without lights

Description	Dimensions cm		Height 221 cm		Height 240 cm	
	W	D	Art. no.	GBP	Art. no.	GBP
 <p>Passe-partout frame, Width per side profiles: 3.2 cm, with lights</p>						
2 lights - for width 150 cm	160	23	718	433,-	727	465,-
4 lights - for width 200 cm	210	23	719	465,-	728	498,-
6 lights - for width 225 cm	235	23	720	530,-	729	565,-
6 lights - for width 250 cm	260	23	721	530,-	730	565,-
6 lights - for width 280 cm	290	23	722	565,-	731	600,-
6 lights - for width 300 cm ⚠ - only for 3-doors wardrobes	310	23	723	565,-	732	600,-
8 lights - for width 300 cm ⚠ - only for 4-doors wardrobes	310	23	724	600,-	733	633,-
8 lights - for width 330 cm	340	23	725	665,-	734	700,-
8 lights - for width 400 cm	410	23	726	700,-	736	735,-

Top view wardrobe
incl. PPT-Frame

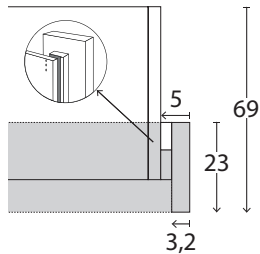

Dimensions cm

This product contains light devices of
energy efficiency class F

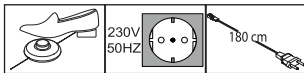

Please note:

Passe-partout frame increases the wardrobe width to the dimensions indicated.

Monaco 3000.

Independent / incl. HDI





RETAIL PRICE LIST

valid

01.03.2023-31.08.2023

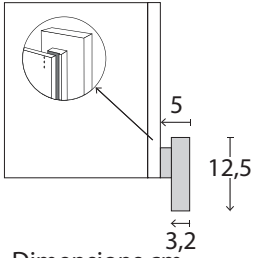
V.i.P.
by Wiemann

Additional elements for sliding door wardrobes

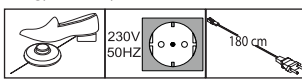
Description	Dimensions cm		Height 221 cm		Height 240 cm	
	W	D	Art. no.	GBP	Art. no.	GBP
 <p>Side profiles in carcase colour, in pairs</p> <p>Top view wardrobe incl. side profiles</p>  <p>Dimensions cm</p>  <p>Suitable for Monaco 1000 + 2000 too!</p>	5	12,5	098	150,-	099	158,-
 <p>Lights for side profiles</p>  <p>Can not get assembled retrospectively! Useabl for side profiles and PPT-Frame without circumferential lights!</p> <p>This product contains light devices of energy efficiency class F</p> 	1,5	1	100	585,-	101	663,-

Cornices for sliding-door wardrobes with or without lights

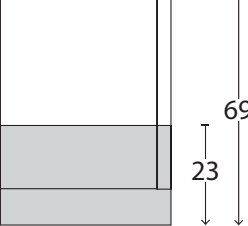
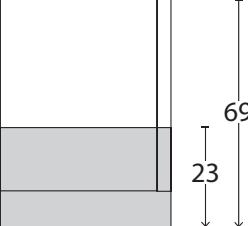
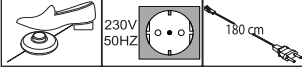
Description	Dimensions cm			Art. no.	GBP
	W	H	D		
 <p>Cornice, without lights</p> <p>- for width 150 cm - for width 200 cm - for width 225 cm - for width 250 cm - for width 280 cm</p> <p>- for width 300 cm ⚠ - only for 3-doors wardrobes</p> <p>- for width 300 cm ⚠ - only for 4-doors wardrobes</p> <p>- for width 330 cm - for width 400 cm</p>					
<p>Top view wardrobe incl. cornice</p>  <p>Dimensions cm</p>					
<p>2 lights - for width 150 cm 4 lights - for width 200 cm 6 lights - for width 225 cm 6 lights - for width 250 cm 6 lights - for width 280 cm</p> <p>6 lights - for width 300 cm ⚠ - only for 3-doors wardrobes</p> <p>8 lights - for width 300 cm ⚠ - only for 4-doors wardrobes</p> <p>8 lights - for width 330 cm 8 lights - for width 400 cm</p>					
<p>Top view wardrobe incl. cornice</p>  <p>Dimensions cm</p>					
<p>This product contains light devices of energy efficiency class F</p> 					

Monaco 3000.

Independent / incl. HDI

RETAIL PRICE LIST

valid

01.03.2023-31.08.2023









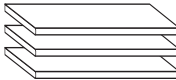

V.i.P.
by Wiemann

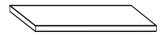
Unit accessories

Interior finish: silver grey striped



When ordering more than one accessory item for a compartment, please make sure that all accessories do not interfere with each other's function.

	Description	Dimensions cm			Art. no.	GBP
		W	H	D		
	1 shelf					
	- for compartment width 72.2 cm 1 item	72,2	2,2	51,5	036	80,-
	- for compartment width 80.1 cm 1 item	80,1	2,2	51,5	032	83,-
	- for compartment width 96.4 cm 1 item	96,4	2,2	51,5	030	83,-
	3 shelves					
	- for compartment width 72.2 cm 3 items	72,2	2,2	51,5	038	135,-
	- for compartment width 80.1 cm 3 items	80,1	2,2	51,5	033	145,-
	- for compartment width 96.4 cm 3 items	96,4	2,2	51,5	031	148,-
	1 shelf for extended corner unit					
	Not for use in conjunction with LED light screens!	88	2,2	88	061	113,-
	1 shelf for extended walk-in corner unit	72,2	2,2	51,5	046	80,-
	1 shelf for 90 degree corner unit with 2 hinged doors	104,4	2,2	104,4	077	175,-
	Not for use in conjunction with LED light screens!					
	1 shelf for 90 degree corner unit with bi-fold doors	152,4	2,2	152,4	078	150,-
	Hanging rail					
	- for compartment width 72.2 cm	72,2	3	2	052	48,-
	- for compartment width 80.1 cm	80,1	3	2	051	50,-
	- for compartment width 96.4 cm	96,4	3	2	050	53,-
	1 hanging rail for extended corner unit	95,8	3	2	082	58,-
	 Only for assembly under one shelf!					
	1 hanging rail for corner unit 90 degree with 2 hinged doors	71,6	3	2	083	58,-
	 Only for assembly under one shelf!					
	1 hanging rail for corner unit 90 degree with bi-fold doors	153	3	2	084	73,-

Monaco 3000.

Independent / incl. HDI

RETAIL PRICE LIST

valid

01.03.2023-31.08.2023



V.i.P.
by Wiemann

Unit accessories

Interior finish: silver grey striped

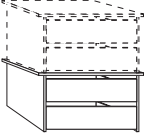
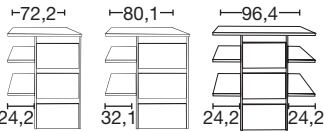
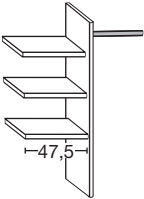

When ordering more than one accessory item for a compartment, please make sure that all accessories do not interfere with each other's function.

	Description	Dimensions cm			Art. no.	GBP
		W	H	D		
	Drawer insert with 2 drawers and glass front for hinged- and sliding-door wardrobes					
	- for compartment width 72.2 cm	72,2	41	52	068	358,-
	- for compartment width 80.1 cm	80,1	41	52	069	380,-
	- for compartment width 96.4 cm	96,4	41	52	070	398,-
	Drawer insert with 2 drawers and wooden front for hinged- and sliding-door wardrobes, stackable and height adjustable					
	- for compartment width 72.2 cm	72,2	41	44	071	380,-
	- for compartment width 80.1 cm	80,1	41	44	072	390,-
	- for compartment width 96.4 cm	96,4	41	44	073	398,-
	Drawer insert with 3 drawers and wooden front					
	- for compartment width 72.2 cm	72,2	89	51,5	023	605,-
	- for compartment width 80.1 cm	80,1	89	51,5	024	620,-
	- for compartment width 96.4 cm	96,4	89	51,5	064	640,-
	Laundry shelf insert, consisting of					
	3 adjustable shelves, 1 hanging rail, 1 mid panel					
	- for compartment width 72.2 cm	72,2	137	51,5	025	250,-
	- for compartment width 80.1 cm	80,1	137	51,5	026	255,-
	- for compartment width 96.4 cm	96,4	137	51,5	066	263,-
	For use on both sides (left or right)!					
	Only to be placed on base plinth!					

Monaco 3000.

Independent / incl. HDI

RETAIL PRICE LIST

valid

01.03.2023-31.08.2023





V.i.P.
by Wiemann

Unit accessories

Interior finish: silver grey striped

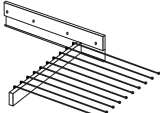
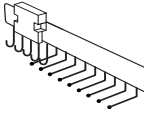
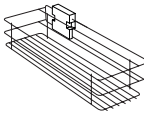
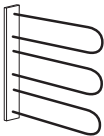
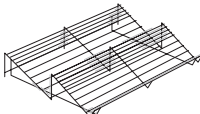

When ordering more than one accessory item for a compartment, please make sure that all accessories do not interfere with each other's function.

Description	Dimensions cm			Art. no.	GBP
	W	H	D		
 <p>LED Light screen for shelves</p> <p>- for compartment width 72.2 cm 1 item - for compartment width 80.1 cm 1 item - for compartment width 96.4 cm 1 item</p> <p>This product contains a light device of energy efficiency class F</p> <p> Not useable for walk-in corner units!</p> <p>- for compartment width 72.2 cm 2 items - for compartment width 80.1 cm 2 items - for compartment width 96.4 cm 2 items</p> <p>- for compartment width 72.2 cm 3 items - for compartment width 80.1 cm 3 items - for compartment width 96.4 cm 3 items</p>	72,2	3	1	002	188,-
	80,1	3	1	016	193,-
	96,4	3	1	011	203,-
	72,2	3	1	003	320,-
	80,1	3	1	017	330,-
	96,4	3	1	013	335,-
	72,2	3	1	004	433,-
	80,1	3	1	018	443,-
	96,4	3	1	015	473,-
	 <p>Trousers holder</p>	45	10	50	056
 <p>Tie and belt pull-out</p>	7	19	45	059	128,-
 <p>Utensil pull-out</p>	16	9	45	076	145,-
 <p>Tie and belt rack</p>	30	27	9	042	68,-
 <p>Shoe rack for</p> <p>- for compartment width 96.4 cm</p> <p> Not for bi-fold wardrobes!</p>	96	15	50	094	118,-

Monaco 3000.

Independent / incl. HDI

RETAIL PRICE LIST

valid

01.03.2023-31.08.2023



V.i.P.
by Wiemann

Unit accessories

Interior finish: silver grey striped

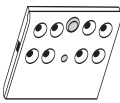
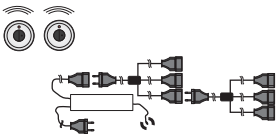

When ordering more than one accessory item for a compartment, please make sure that all accessories do not interfere with each other's function.

Description	Dimensions cm			Art. no.	GBP
	W	H	D		
 <p>Clothes lift for compartment width 72.3 - 96.4 cm</p>	100	85	14	081	213,-
 <p>Fold-out interior mirror</p> <p>Only in conjunction with sliding-door wardrobes!</p> <p> Not for use in conjunction with LED light screens!</p>	36	173	2	080	255,-
 <p>LED Wardrobe interior lights with motion detector, incl. rechargeable battery via USB</p> <p>1 item</p> <p>2 items</p> <p>3 items</p> <p>4 items</p>	10	2	10	006	113,-
	10	2	10	007	183,-
	10	2	10	008	263,-
	10	2	10	009	335,-
 <p>Radio receiver for lights with 2 transmitters for connection to up to 5 loads</p>	40	9	13	005	283,-

Monaco 3000.

Sliding door wardrobes.

V.i.P.
by Wiemann



Independent / incl. HDI

RETAIL PRICE LIST

valid

01.03.2023-31.08.2023



Emission Tested
Tested for Harmful
Substances
Regular Product
Surveillance

www.tuv.com
ID: 1111253053



Monaco 3000.

Sliding door wardrobes.

V.i.P.
by Wiemann



Independent / incl. HDI

RETAIL PRICE LIST

valid

01.03.2023-31.08.2023



Emission Tested
Tested for Harmful
Substances
Regular Product
Surveillance

www.tuv.com
ID: 1111253053



Monaco 3000.

Sliding door wardrobes.

V.i.P.
by Wiemann



Extended corner unit



Walk-in corner unit



Corner unit, 90 degree with hinged-doors



Corner unit, 90 degree with bi-fold doors

Independent / incl. HDI

RETAIL PRICE LIST

valid

01.03.2023-31.08.2023



Emission Tested
Tested for Harmful
Substances
Regular Product
Surveillance

www.tuv.com
ID: 1111253053

